

Data Sheet



Article number: 51803163000010

Description: Vibration damper GP-QP 40x32
NR shore 57

Measures

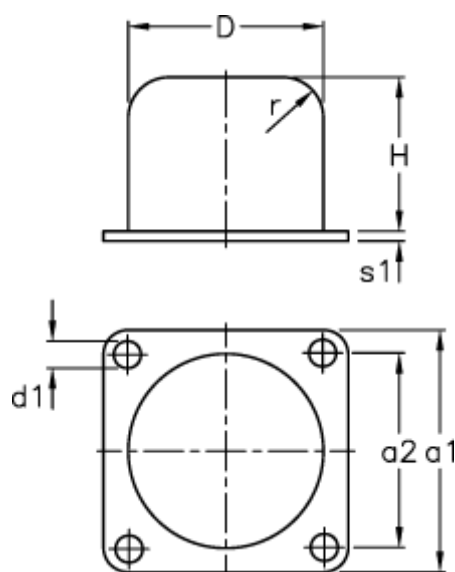

a1	= 50	r = 8.0
a2	= 40	s1 = 2
D	= 40	
d1	= 5.5	
H	= 32	
Load capacity F (kN)	= 15.0	
Load capacity f (mm)	= 18	
Load capacity W (J)	= 70	